

Instruction Manual

225 SERIES

IEEE-488 Programmable High Voltage Power Supply

**SPELLMAN
HIGH VOLTAGE ELECTRONICS
CORPORATION**

One Commerce Park
Valhalla, New York, 10595

+1(914) 686-3600* FAX: +1(914) 686-5424*

E-mail: sales@spellmanhv.com

Website: www.spellmanhv.com

USA

EUROPE

JAPAN

MEXICO

IMPORTANT SAFETY PRECAUTIONS

SAFETY

THIS POWER SUPPLY GENERATES VOLTAGES THAT ARE DANGEROUS AND MAY BE FATAL.
OBSERVE EXTREME CAUTION WHEN WORKING WITH THIS EQUIPMENT.

High voltage power supplies must always be grounded.

Do not touch connections unless the equipment is off and the Capacitance of both the load and power supply is discharged.

Allow five minutes for discharge of internal capacitance of the power supply.

Do not ground yourself or work under wet or damp conditions.

SERVICING SAFETY

Maintenance may require removing the instrument cover with the power on.

Servicing should be done by qualified personnel aware of the electrical hazards.

WARNING note in the text call attention to hazards in operation of these units that could lead to possible injury or death.

CAUTION notes in the text indicate procedures to be followed to avoid possible damage to equipment.

Copyright © 2000, Spellman High Voltage Electronics Corporation. All Rights Reserved.
This information contained in this publication is derived in part from proprietary and patent data. This information has been prepared for the express purpose of assisting operating and maintenance personnel in the efficient use of the model described herein, and publication of this information does not convey any right to reproduce it or to use it for any purpose other than in connection with installation, operation, and maintenance of the equipment described.

WICHTIGE SICHERHEITSHINWEISE

SICHERHEIT

DIESES HOCHSPANNUNGSNETZTEIL ERZEUGT LEBENSGEFÄHRLICHE HOCHSPANNUNG.
SEIN SIE SEHR VORSICHTIG BEI DER ARBEIT MIT DIESEM GERÄT.

Das Hochspannungsnetzteil muß immer geerdet sein.

Berühren Sie die Stecker des Netzteiles nur, wenn das Gerät ausgeschaltet ist und die elektrischen Kapazitäten des Netzteiles und der angeschlossenen Last entladen sind.

Die internen Kapazitäten des Hochspannungsnetzteiles benötigen ca. 5 Minuten, um sich zu entladen.

Erden Sie sich nicht, und arbeiten Sie nicht in feuchter oder nasser Umgebung.

SERVICESICHERHEIT

Notwendige Reparaturen können es erforderlich machen, den Gehäusedeckel während des Betriebes zu entfernen.

Reparaturen dürfen nur von qualifiziertem, eingewiesenem Personal ausgeführt werden.

“WARNING” im folgenden Text weist auf gefährliche Operationen hin, die zu Verletzungen oder zum Tod führen können.

“CAUTION” im folgenden Text weist auf Prozeduren hin, die genauestens befolgt werden müssen, um eventuelle Beschädigungen des Gerätes zu vermeiden.

PRECAUTIONS IMPORTANTES POUR VOTRE SECURITE

CONSIGNES DE SÉCURITÉ

CETTE ALIMENTATION GÉNÈRE DES TENSIONS QUI SONT DANGEUREUSES ET PEUVENT ÊTRE FATALES.
SOYEZ EXTRÊMEMENT VIGILANTS LORSQUE VOUS UTILISEZ CET ÉQUIPEMENT.

Les alimentations haute tension doivent toujours être mises à la masse.

Ne touchez pas les connectiques sans que l'équipement soit éteint et que la capacité à la fois de la charge et de l'alimentation soient déchargées.

Prévoyez 5 minutes pour la décharge de la capacité interne de l'alimentation.

Ne vous mettez pas à la masse, ou ne travaillez pas sous conditions mouillées ou humides.

CONSIGNES DE SÉCURITÉ EN CAS DE REPARATION

La maintenance peut nécessiter l'enlèvement du couvercle lorsque l'alimentation est encore allumée.

Les réparations doivent être effectuées par une personne qualifiée et connaissant les risques électriques.

Dans le manuel, les notes marquées « **WARNING** » attire l'attention sur les risques lors de la manipulation de ces équipements, qui peuvent entraîner de possibles blessures voire la mort.

Dans le manuel, les notes marquées « **CAUTION** » indiquent les procédures qui doivent être suivies afin d'éviter d'éventuels dommages sur l'équipement.

IMPORTANTI PRECAUZIONI DI SICUREZZA

SICUREZZA

QUESTO ALIMENTATORE GENERA TENSIONI CHE SONO PERICOLOSE E POTREBBERO ESSERE MORTALI.
PONI ESTREMA CAUTELA QUANDO OPERI CON QUESTO APPARECCHIO.

- Gli alimentatori ad alta tensione devono sempre essere collegati ad un impianto di terra.
- Non toccare le connessioni a meno che l'apparecchio sia stato spento e la capacità interna del carico e dell'alimentatore stesso siano scariche.
- Attendere cinque minuti per permettere la scarica della capacità interna dell'alimentatore ad alta tensione.
- Non mettere a terra il proprio corpo oppure operare in ambienti bagnati o saturi d'umidità.

SICUREZZA NELLA MANUTENZIONE.

- Manutenzione potrebbe essere richiesta, rimuovendo la copertura con apparecchio acceso.
- La manutenzione deve essere svolta da personale qualificato, coscio dei rischi elettrici.
- Attenzione alle **AVVERTENZE** contenute nel manuale, che richiamano all'attenzione ai rischi quando si opera con tali unità e che potrebbero causare possibili ferite o morte.
- Le note di **CAUTELA** contenute nel manuale, indicano le procedure da seguire per evitare possibili danni all'apparecchio.

TABLE OF CONTENTS

I.	INTRODUCTION	
	1.0 Scope of Manual.....	3
	1.1 Purpose of Equipment.....	3
	1.2 Description.....	3
II.	OPERATION	
	2.1 Installation.....	3
	2.2 Input Power.....	3
	2.3 Power On / Self-Test.....	3
	2.4 High Voltage Control.....	4
	2.5 Polarity Reversal.....	4
	2.5.1 Polarity Reversal – 500V to 5kV Output Models.....	4
	2.5.2 Polarity Reversal – 10kV to 50kV Output Models.....	4
III.	GPIB OPERATIONS	
	3.1 Program Control Switch.....	4
	3.2 GPIB Address Switch.....	4
	3.3 GPIB Protocol.....	5
	3.3.1 Data Transfer Functions – SH1, T5, CO, AH1, PPO.....	5
	3.3.2 Service Request Functions – SR1.....	5
	3.3.2.1 Service Request (SRQ).....	5
	3.3.2.2 Serial Poll (SPL).....	5
	3.3.3 Device Clear Function – DCI.....	6
	3.3.4 Device Trigger Function – DT1.....	6
	3.4 User Commands.....	6
	3.4.1 Programming the High Voltage Output (“P”).....	6
	3.4.1.1 Programming the Output Voltage as a Percentage.....	7
	3.4.2 Setting the Output Limits (“L”).....	7
	3.4.3 Entering the Current Programming & Limit Values (“G”).....	7
	3.4.4 Shutting the high Voltage Output Off (“Z”).....	7
	3.4.5 Restoring the high Voltage Output (“R”).....	7
	3.4.6 Selecting the Overload Trip Response (“OE” and “OC”).....	7
	3.4.7 Selecting the Overload Service Request Respons (“SE” and “SC”).....	7
	3.4.8 Triggering Meter Readings of the Output (“T”).....	7
	3.4.9 Status “M”).....	8
	3.5 Sample Computer Programs.....	8

IV.	FRONT PANEL CONTROLS	
	4.1 Functional Description.....	8
	4.2 Program Control Switch.....	9
	4.3 Local Operation.....	9
	4.3.1 Choice of Overvoltage Trip Response (“OE”).....	9
	4.3.2 Choice of Overcurrent Trip Response (“OC”).....	9
	4.3.3 Choice of Overvoltage Service Request Response (“SrE”)..	9
	4.3.4 Choice of Overcurrent Service Request Response (“SrC”)..	10/11
	4.4 Front Panel Messages.....	11
	4.5 Operation Examples.....	11
	4.5.1 Output Voltage Setting.....	11
	4.5.2 Output Voltage Adjustment.....	11
	4.5.3 Setting the Output Voltage Limit.....	11
	4.5.4 Setting the Output Current Limit.....	11
V.	REMOTE ANALOG OPERATION	
	5.1 Program Control Switch.....	12
	5.2 Remote Control.....	12
	5.3 Analog Monitoring Signals.....	12
VI.	MAINTENANCE	
	6.1 General.....	12
VII.	APPENDIX	
	7.1 IBM PC/XT/AT/(DOS 3.1 or Higher Required).....	12/13
	7.2 IBM PS/2 Using IO Tech Interface (DOS 3.1 or Higher Required)....	13
	7.3 HP 85/86/87.....	13
	7.4 HP9825A.....	13
	7.5 Floating Option (“RF”).....	14

THIS UNIT CONTROLS HAZARDOUS VOLTAGES. DO NOT APPLY INPUT POWER UNLESS ADEQUATE GROUNDING IS PROVIDED TO THE POWER SUPPLY AND THE HIGH VOLTAGE OUTPUT HAS BEEN PROPERLY CONNECTED.

THE DATA CONTAINED IN THIS MANUAL IS SUBJECT TO CHANGE WITHOUT NOTICE. WRITTEN PERMISSION FROM SPELLMAN HIGH VOLTAGE IS REQUIRED PRIOR TO THE REPRODUCTION OF ANY TECHNICAL DATA CONTAINED IN THIS MANUAL.

SECTION I: INTRODUCTION

1.0 SCOPE OF MANUAL

This manual is provided to assist the user in the installation and operation of the Spellman Series 225, IEEE-488 (GPIB) programmable high voltage power supplies. Statements apply to all models in the Series unless reference is made to specific models. For the protection of personnel and equipment, it is essential that this manual be thoroughly read prior to the installation and application of power.

1.1 PURPOSE OF EQUIPMENT

The series 225 is a family of regulated precision regulated, GPIB programmable high voltage power supplies. They offer exceptional performance in such critical applications as nuclear and electro-optical instrumentation, medical imaging and capillary zone electrophoresis and precision CRT displays.

1.2 DESCRIPTION

The units are fully enclosed and designed to mount in a standard 19" rack. A wide range of stable output voltages from 500V up to 50 kV is available. The output voltage is set either by front panel controls or on the IEEE-488 interface. Intelligent programming, monitoring and automatic overload protection of the power supply are provided. Remote analog voltage or resistance programming and remote analog monitoring are provided on all models.

Output polarity reversal is achieved by turning a polarity switch on the rear panel of 500V, 1kV, 3kV and 5kV models. The 10kV and higher output models have an internal polarity reversing assembly that is easily accessible in the field. NOTE: in either case, polarity reversal MUST ONLY BE DONE WHEN THE HIGH VOLTAGE IS OFF.

The Series 225 units contain a DC power supply that converts the AC line power to a low voltage DC and a DC-to-DC converter that generates the high DC voltage. Low voltage electronics solid-state circuits (analog and microprocessor-controlled circuits) are placed on plug-in printed circuit boards. The high voltage assembly is fully encapsulated in silicone rubber for reliable, arc-free, stable operation.

SECTION II: OPERATION

CAUTION! THIS UNIT CAN STORE HAZARDOUS VOLTAGE. COMPLETELY DISCHARGE HIGH VOLTAGE AT REAR PANEL GROUND TERMINAL BEFORE ATTEMPTING REMOVAL OF THE HIGH VOLTAGE CABLE

2.1 INSTALLATION:

The 225 Series high voltage power supplies mount in a standard 19" rack.

2.2 INPUT POWER

The input AC line voltage required is 115V/230VAC, $\pm 10\%$, 50-400Hz, single phase. The LINE VOLTAGE selector switch on the rear panel MUST BE SET for either 115VAC or 230VAC BEFORE application of input power.

2.3 POWER ON/SELF TEST

When AC power is first applied, the unit will automatically illuminate all of its LED segments in the front panel display for user inspection. Then it will display its configuration as shown in the EXAMPLE 2.1 below

DISPLAY EXAMPLE 2.1

“+225.0.5” 225-0.5R set to positive output polarity

“-225.30” 225-30R set to negative polarity

While the above is being displayed, the unit performs a series of power-on self-tests. If the internal self-check detects a failure, that failure will be displayed as one of the following error messages:

error	E r r 1	μ P RAM
error	E r r 2	μ P ROM
	E r r 3	μ P A/D error

The above messages are also available via the IEEE-488 interface. (See Section 3.2.2). If no error is found, the unit will commence displaying voltage readings.

2.4 VOLTAGE CONTROL

The 225 Series power supply has three modes of controlling the high voltage outputs available to the user. Set the PROGRAM CONTROL switch (S101) on the rear panel to LOCAL/IEEE-488 for front panel control or for remote IEEE-488 control. For remote analog control, set the switch to the REMOTE ANALOG position. The high voltage output can then be remotely programmed either from an external voltage source or by using an external potentiometer. When S101 is in the REMOTE ANALOG position, the front panel controls will have no effect on the output voltage setting.

At all times, regardless of the position of the rear panel PROGRAM CONTROL switch or the GPIB status (Local, Remote or Local Lockout), the user may enable or disable the high voltage output by switching the HV ENABLE switch on the front panel. In addition, the voltage and current monitors are always active. Thus, even when the PROGRAM CONTROL switch is set to REMOTE ANALOG control position or the GPIB has brought the unit to remote or local lockout, the front panel, the GPIB and the remote analog monitors continue to make voltage and current readings available.

2.5 POLARITY REVERSAL

The front panel LED display will indicate which polarity the unit is set for. The display illuminates even if there is no high voltage output.

CAUTION – LINE INPUT POWER MUST BE TURNED OFF AND THE HIGH VOLTAGE SHOULD BE DISCHARGED FULLY BEFORE PROCEEDING TO REVERSE THE POLARITY.

2.5.1 POLARITY REVERSAL 500V TO 5kV OUTPUT MODELS

The screwdriver-rotatable POLARITY SELECTOR switch (S3) is accessible at the rear panel of the unit. Rotate as required for the desired polarity.

2.5.2 POLARITY REVERSAL 10kV TO 50kV OUTPUT MODELS

The polarity is reversible by means of an internal polarity module, which is easily accessible upon removal of the top cover. Polarity is reversed by removing two diagonally opposed Philips head screws, lifting up on the module, rotating it 180°, and then reinserting it. A safety interlock automatically ensures that the high voltage cannot be turned on unless this module is fully seated and installed in one polarity position or the other.

A remote polarity indication is provided at J107 (PROGRAMMING/MONITOR) connector jack located on the rear panel of the unit (see section 5.3).

SECTION III: GPIB OPERATION

CAUTION! THIS UNIT CAN STORE HAZARDOUS VOLTAGE. COMPLETELY DISCHARGE HIGH VOLTAGE AT REAR PANEL GROUND TERMINAL BEFORE ATTEMPTING REMOVAL OF THE HIGH VOLTAGE CABLE

3.1 PROGRAM CONTROL SWITCH

Before a unit of the 225 Series may be used in a GPIB system, the user must set the power supply's rear panel PROGRAM CONTROL switch (S101) in the LOCAL/IEEE-488 position.

3.2 GPIB ADDRESS SWITCH

An eight-position DIPswitch (S9) is located on the rear panel of the unit. Every instrument on a GPIB system must have a unique bus address in the range 0 to 30, inclusive. A unit's address is set using S9 switch positions A4 through A0. A4 is the most significant address bit and A0 the least significant bit. Bit A5 of the address switch will enable or disable the power-on Service Request. Bit A6 controls whether the power supply will terminate its output character strings with our without a carriage return and a linefeed. Bit A7 must remain in the logic 0 state. Figure 3.1 shows the switch orientation and bit designations.

S9 is read ONLY at power-on. Therefore, when any of the above is to be changed, the unit must first be turned off, the required changes made and then the unit must be turned back on.

FIGURE 3.1 REAR PANEL GPIB ADDRESS SWITCH

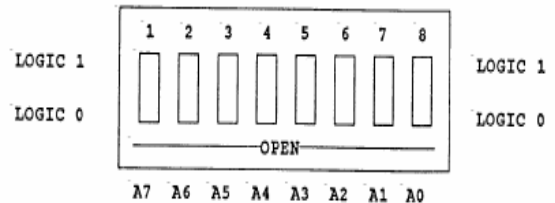

A7	Set to 0	
A6	Line Terminators:	1 Carriage
	Return & Linefeed (CR/LF) (*)	0 No Line Terminators
A5	Service Request:	1 Service
	Request sent at power-on	0 No Service Request is sent at power-on
A4	GPIB Address MSB	
A3	GPIB Address Bit	
	(*) Line terminators are or are not appended to the A2GPIB Address Bit returned strings described in sections 3.4.8 and 3.4.9 based on the settings of A6	
A2	GPIB Address Bit	

A1 GPIB Address Bit
A0 GPIB Address Bit

FACTORY SETTING:

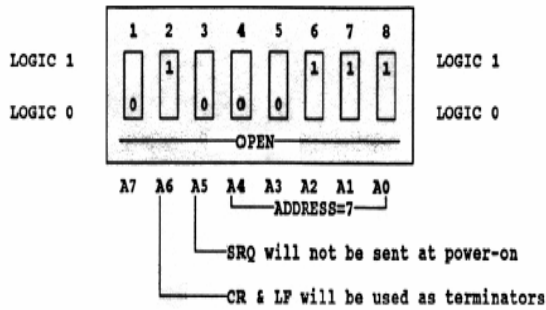

ALTERNATIVE EXAMPLE:

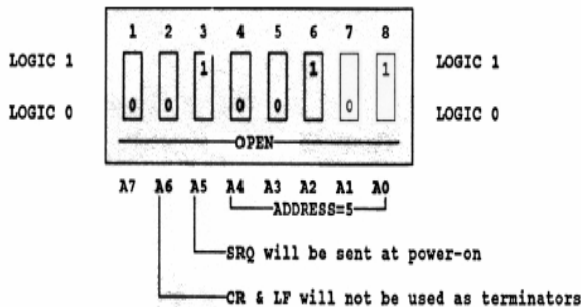

3.3 GPIB PROTOCOL

The 225 Series implements the following GPIB functions:

- SH1 Source Handshake
- AH1 Acceptor Handshake
- T5 Basic Talker & Serial Poll L4 Basic Listener
- RL1 Remote/Local with Lockout
- PPO No parallel poll response
- CO Not a controller
- SR1 Service Request
- DC1 Device Clear
- DT1 Device Trigger

Using these GPIB functions, the GPIB controller can send ASCII command strings to control and monitor the high voltage power supply.

3.3.1 DATA TRANSFER FUNCTIONS – SH1, T5, CO, AH1, PPO

These seven data transfer functions are normally transparent to the user. They permit communication between the GPIB controller and the 225 Series high voltage power supplies.

3.3.2 SERVICE REQUEST FUNCTIONS – SR1

SR1 contains two sub-functions: Service Request and Serial Poll. The service request (SRQ) is the mechanism by which a power supply can interrupt the GPIB controller and the serial poll (SPL) is how the GPIB controller can read the status of the power supply.

3.3.2.1 SERVICE REQUEST (SRQ)

There are three conditions that can make a power supply issue an SRQ. They are 1) at power-on, 2) in response to an overload detection and 3) in response to receipt of an invalid command. The meaning of the serial poll status byte depends upon what caused the service request. The power-on byte is true when the power supply is first turned on AND the GPIB controller has not yet sent a valid command to the unit. The “normal operation” byte is true after the GPIB controller has sent its first valid command to the unit. Any service request can be ignored without affecting operation of the GPIB interface or of the power supply.

3.3.2.2 SERIAL POLL (SPL)

When the GPIB controller executes a serial poll, the power supply sends it one status byte. As mentioned above, decoding of that byte depends on when it is read. The figures below show the decoding of the “power-on” status byte and “normal operation” (not the “power-on”) status byte.

Figure 3.2

At power-on before any command is sent, the status byte is:

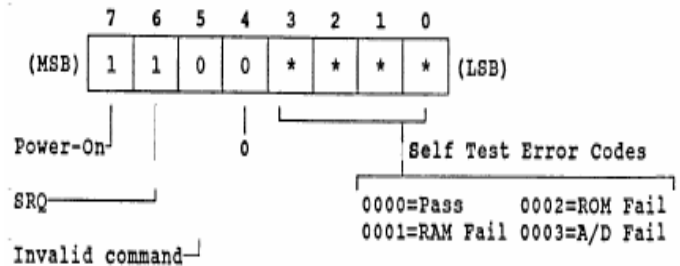

If SRQ = 1, pole A5 of the GPIB address was set for “SRQ” at “power-on”.

Bit #7 is at logic 1. That shows this is the status register contents at power-on, prior to the issuance of a valid command. If you don’t do a serial poll at power-on, but simply send any valid command, the status byte obtained in response to subsequent serial polls will instead be as seen in Figure 3.3 below.

Bit #5 and Bit# 6 function identically as in the normal operation status byte of FIGURE 3.3 below:

Figure 3.3

After the first valid command, the status byte looks like this:

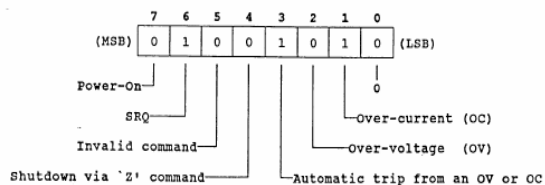

Bit #7 is at logic 0. That shows this is the status register contents following the issuance of at least one valid GPIB command since power-on.

If bit# 6 is at logic 0, the status byte obtained is in response to the first serial poll taken after first issuance of an SRQ. If bit #6 is at logic 0, the status byte obtained was examined before and/or is not related to an SRQ.

EXAMPLE BIT PATTERN:



BIT# MEANING:

- 7 0: You are looking at the status byte after at least one command.
- 6 1: This is the first look at status after the issuance of an SRQ.
- 5 1: The last command you issued was not valid.
0: The last command you issued was valid.
- 4 1: You have shut down the unit with a “Z” command or DC1
0: The unit is not in a shut down state.
- 3 1: The high voltage was tripped off in response to an overload.
0: The unit is not tripped.
- 2 1: The supply is in voltage overload.
0: The supply is not in voltage overload.
- 1 1: The supply is in current overload.
0: The supply is not in current overload.
- 0 0: This bit of the status byte is always logic 0.

3.3.3 DEVICE CLEAR FUNCTION – DC1

The device clear and selective device clear GPIB functions trip the high voltage output to zero volts regardless of the actual voltage program. They perform identically to the user command “Z” of section 3.4.4.

3.3.4 DEVICE TRIGGER FUNCTION – DT1

The device trigger function updates the previously programmed parameters. It performs identically to user command “G” of section 3.4.3, but has the additional capability to trigger multiple bus instruments simultaneously.

3.4 USER COMMANDS

The unit recognizes certain received ASCII strings as commands from the GPIB controller that execute all of the unit’s functions. They are:

- Programming the Output Voltage in Percentage (“%”)
- Programming the Output Voltage (“P”)
- Setting Output Voltage and Current Limits (“L”)
- Executing (“going ahead with”) the Last Issued Commands (“G”)
- Shutting Off or Zeroing the High Voltage Output (“Z”)
- Restoring the High Voltage Output (“R”)
- Selecting the Overload Shutdown Response (“OE” or “OC”)
- Selecting the Overload Service Request Response (“SE” & “SC”)
- Triggering Meter Readings of the output (“T”)
- Polarity, Model Number & Software Revision Information (“M”)

NOTE: All characters in the ASCII command string must be in UPPER CASE ONLY. The interface will not recognize lower case letters.

Program, Limit and Meter command syntax varies depending upon specific model. Table 3.0 shows the Program, Limit and Meter command formats for the 225 Series high voltage power supplies.

TABLE 3.0

NUMERIC FORMATS FOR PROGRAM, LIMIT & METER COMMANDS:		
	FORMAT	
MODEL	VOLTAGE	CURRENT
225-0.5	0.xxxxx	xx.xxx
225-01	x.xxxx	xx.xxx
225-03	x.xxxx	xx.xxx
225-05	x.xxxx	xx.xxx
225-10	x.xxxx	xx.xxx
225-20	x.xxxx	xx.xxx
225-30	x.xxxx	xx.xxx
225-30	x.xxxx	xx.xxx

3.4.1 PROGRAMMING THE HIGH VOLTAGE OUTPUT (“P”)

This command allows the user to set the output voltage of the power supply. The syntax is:

“P {numeric string}K”

Where {numeric string} is an ASCII string of the required number of digits and a decimal point. The resolution of the programming meter values is five digits. Since each model power supply has its own output rating, the programming command will have its own format. In general, the programming command will be one of those shown below:

P0.xxxxxK (For 500V model)
Px.xxxxK (For 1kV, 3kV and 5kV models)
Pxx.xxxK (For 10kV, 20kV, 30kV and 50kV models)

The numeric format will depend upon the unit being controlled. This numeric format can be packed with zeroes to fully five digits. Therefore, if a 225-01R (1kV model) power supply is to be programmed to only 230V, the command could be P0.23K or P0.2300K. Similarly, if a 225-20R (20kV model) power supply is to be programmed to 11,500V the command could be either P11.500K or P11.5K.

The actual high voltage output will not change to a newly programmed value after a program command has been issued until the unit also receives a device trigger bus command or the “G” command string (see sections 3.3.4 and 3.4.3).

3.4.1.1 PROGRAMMING THE OUTPUT VOLTAGE AS A PERCENTAGE

This command allows the user to set the output voltage of the power supply to some percent of maximum output voltage. The syntax is:

“P (numeric string) %K”

Where (numeric string) is an ASCII string of the required number of digits and a decimal point. The resolution of the programming and meter values is four digits.

Pxx.xx%K (for zero to maximum rated output voltage for all supplies)

The actual high voltage output will not change to a newly programmed value after a program command has been issued until the unit also receives a device trigger bus command or the “G” command string (see sections 3.3.4 and 3.4.3).

3.4.2 SETTING THE OUTPUT LIMITS (“L”)

Each unit monitors output voltage and current to detect if those parameters exceed the user-set thresholds. Each parameter (voltage and current) is monitored at the rate of once per second. The user may set threshold limits that, when exceeded, will invoke the user programmed shut down and service request responses (see sections 3.4.6 and 3.4.7). The limit commands consist of an “L”, a numeric string that represents the threshold value and a final character that distinguishes between the voltage and

current limits. A “K” indicates a kilovolt limit and an “M” or “U” indicates a milliamp or microamp limit, respectively. The syntax is:

“L{numeric string}K” Kilovolt Limit (All models)
“L{numeric string}M” Milliamp Limit (All models except 30kV & 50kV)
“L{numeric string}U” Microamp Limit (Models 225-30R & 225-50R only)

Where {numeric string} is as described in Table 3.0. Note: In some cases, the numeric formats for the voltage and current will be different.

The voltage limit command uses the same numerical format as the programming command, but starts with an “L”. Below are some examples:

Lx.xxxxK L0.6523k limits to 652.3V
Lxx.xxxK L29.400K limits to 29.4V

The output current limit threshold may also be set. When this value is exceeded, the unit will respond as previously programmed by the user. Below are some examples of the current limit command:

Lxx.xxxxM L12.000M limits to 12mA
Lx.xxxxM L1.0500M limits to 1.05mA
Lxxx.xxU L473.50U limits to 473.5µA (Models 225-30R & 225-50R only)

An actual limit value will not change to a newly programmed value after a limit command has been issued until after the unit also receives a device trigger bus command or the “G” command string (see sections 3.3.4 and 3.4.3)

3.4.3 ENTERING THE CURRENT PROGRAMMING & LIMIT VALUES (“G”)

After executing a programming or limit command, these new values will not be used immediately.

The user must execute the “G” command, which will update the old values with the new ones. Therefore, if the output is presently programmed to 1kV and the user executes a program command such as “P1.5000K”, the output will not change to 1.5kV until the “G” command is executed. The syntax is:

“G” the single ASCII character

When timing is not important, the “G” may be appended to the programming or limit command as shown below:

Pxx.xxxKG
Lx.xxxxMG

3.4.4 SHUTTING THE HIGH VOLTAGE OUTPUT OFF (“Z”)

The user may turn off the high voltage output without affecting the currently active programmed value. The syntax is:

“Z” the single ASCII character

This has the same effect as executing the device clear bus command.

3.4.5 RESTORING THE HIGH VOLTAGE OUTPUT (“R”)

The high voltage output may be turned back on to the currently active programming value after having been shut off by a user command “Z” or by a trip due to overload. The syntax is:

“R” the single ASCII character

The high voltage output will return to the value that was programmed before the shut down. If the output was turned off by an overload trip, the cause of the overload should be corrected before trying to restore the output voltage or the trip will occur again.

3.4.6 SELECTING THE OVERLOAD TRIP RESPONSE (“OE” & “OC”)

When the unit detects that the output has exceeded one of the user programmed limits, it may respond by shutting off the high voltage output, also called tripping. The user may select that the power supply trip itself for a voltage overload only, for a current overload only, for a voltage or a current overload, or for neither. The syntax is:

“OE {numeric}”

“OC {numeric}”

Where {numeric} is the ASCII character for 0, 1, or 2 and:

OE2 Establishes that the unit cannot be programming to a voltage value above the voltage limit setting.

OE1 Enables the unit to shut down its output upon detection of an output voltage above the voltage limit setting.

OE0 Establishes that the unit will not shut down its output in response to the detection of an output voltage above the voltage limit setting.

OC1 Enables the unit to shut down its output upon detection of an output current above the current limit setting.

OC1 Establishes that the unit will not shut down its output in response to the detection of an overload current greater than the current limit setting.

3.4.7 SELECTING THE OVERLOAD SERVICE REQUEST RESPONSE (“SE” & “SC”)

Just as the unit can be made to shut off the output in response to an overload, it can also be made to generate a service request to the GPIB controller in response to an overload. The syntax is:

“SE {numeric}”

“SC {numeric}”

where {numeric} is the ASCII byte for 0 or 1 and:

SE1 Enables SRQ in response to an overvoltage detection

SE0 Disables SRQ in response to an overvoltage detection

SC1 Enables SRQ in response to an overcurrent detection

SC0 Disables SRQ in response to an overcurrent detection

When the unit sends an SRQ to the GPIB controller, the user should execute a serial poll of the unit to obtain its status byte. Please note that the overload response choices and the service request choices operate independently of each other.

3.4.8 TRIGGERING METER READINGS OF THE OUTPUT (“T”)

Each unit has the capability to perform meter readings of its output voltage and current. The user may trigger a reading of the output voltage, the output current or both.

The syntax is:

“T {numeric}”

Where {numeric} is the single ASCII character for 0, 1 or 2 and:

T0 Triggers a measurement of the output voltage and current

T1 Triggers a measurement of the output current only

After receiving one of the “T” commands, the unit will return a character string containing output status (Normal, Tripped or Shutdown) and voltage and/or current readings. The numerical formats are those used to enter voltage and current values.

Below are the “T” commands with some typical strings that are returned to the GPIB controlled in response:

T0 “N Vxx.xxxK Ix.xxxxM”

Note: These strings are, or are not, followed

T1 “S Vx.xxxxK”

by Line Terminators CR/LF depending

T2 “T Ixxx.xxU”

upon the chosen setting of switch S9,

Position A6 (see section 3.2)

A leading “N” in the string means that the output is on. A leading “S” means that the output was shut down by the user with a “Z” command or a device clear bus command. A leading “T” means that the output was tripped due to an overload detection. Also:

“V” in the string means voltage

“I” in the string means current

“K” in the string means kilovolts

“M” in the string means milliamps

“U” in the string means microamps

3.4.9 STATUS (“M”)

After receiving the “M” command, the unit will return a character string with its model number, output polarity setting and software revision. The syntax is:

“M” the single ASCII character

In the returned string, the “+225.03 re0.8” would denote a positive high voltage output from 0 to +3kV and the use of revision 0.8 software. The use of CR/LF Line Terminators depends on S9, position A6 as above.

3.5 SAMPLE COMPUTER PROGRAMS

Sample computer programs for use with the Series 225 can be found in the APPENDIX of this manual. Each sample sends series commands to the power supply and shows response via the computer’s display.

SECTION IV: LOCAL OPERATION

CAUTION! THIS UNIT CAN STORE HAZARDOUS VOLTAGE. COMPLETELY DISCHARGE HIGH VOLTAGE AT REAR PANEL GROUND TERMINAL BEFORE ATTEMPTING REMOVAL OF THE HIGH VOLTAGE CABLE

4.1 FRONT PANEL CONTROLS

Figure 4.1 below is the typical layout of the 225 Series front panel

Figure 4.1

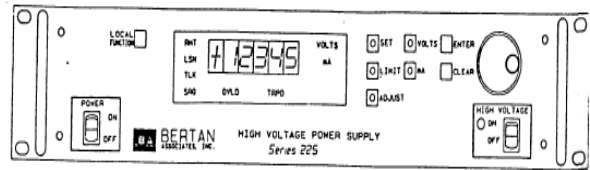

SWITCHES/PUSHBUTTONS/INDICATORS/DIALS FUNCTION/PURPOSE

POWER ON-OFF

Enables and disables AC power

HIGH VOLTAGE ON-OFF

Enables and Disables high voltage. This front panel switch overrides ALL controls in disabling of the high voltage output.

LOCAL/FUNCTION

Brings unit from GPIB control to front panel control. It gives the user access to programming features and to model information.

SET Used to set the output voltage

LIMIT Used to program the output voltage limit and output current limit.

ADJUST Used to adjust the output voltage

VOLTS Enables the display to show output voltage readings. It is used when changing the output voltage or the output voltage limit.

Ma Enables the display to show output current readings. It is used when changing the output current limit.

ENTER Finishes a command entry

CLEAR Used to abort a command sequence.

DIGITAL POTENTIOMETER

For entering numeric and mode selections with velocity-variable action. Resolution is very high when turned slowly. If turned rapidly, value changes are rapid.

LED DISPLAY

Five digits which show voltage and mA/μA readings and mode settings.

RMT Remote/Local status of GPIB

LSN Listener status of GPIB

TLK Talker status of GPIB

SRQ	Service request status of GPIB
OVL D	Output overload indicator
TRPD	Output trip indicator
VOLTS	Illuminated when the meter is displaying the output current.
mA	Illuminated when the meter is displaying the output current.

4.2 PROGRAM CONTROL SWITCH

The front panel controls of the unit are only functional for programming purposes when the unit's rear panel PROGRAM CONTROL switch (S101) is in the LOCAL/IEEE-488 position. However, if the unit receives a voltage programming command while S101 is in the Remote Analog position, the switching of S101 to its LOCAL/IEEE-488 position afterwards will then cause the value of that programming command to take effect.

4.3 LOCAL OPERATION

The local mode of the 225 Series provides all of the control and monitoring functions available with GPIB control. An SRQ may occur with no controller connected to the IEEE-488 connector port (J9). The SRQ front panel LED will illuminate and stay illuminated, but this is of no concern when in the Local mode. Any unanswered SRQ will not affect local control in any way and the illuminated LED may be safely ignored.

When the unit is in remote control via the GPIB, the user must press the LOCAL/FUNCTION pushbutton on the front panel to enter the Local mode. If the remote (RMT) LED is not illuminated, then the unit is in the Local mode.

If the user chooses, the unit can be programmed from the GPIB to receive programming information only from the GPIB.

Then, in response to pressing LOCAL/FUNCTION, the unit will display "LLO" on its front panel display, meaning Local lockout. In that case, only the GPIB controller will be able to program the high voltage output.

In Local mode, seven sequential pressings of the LOCAL/FUNCTION pushbutton display the following seven items:

- GPIB address that the user has selected for the unit.
- Model number and output polarity setting (see DISPLAY EXAMPLE 2.1)
- Overvoltage trip response setting: OE 0, OE 1 or OE 2

- Overcurrent trip response setting: OC 0 or OC 1
- Overvoltage service request response setting: SrE 0 or SrE 1
- Overcurrent service request response setting: SrC 0 or SrC 1
- Software revision number

For a new OE, OC, SrE or SrC choice, press the LOCAL/FUNCTION pushbutton to obtain the old choice display. Then rotate the DIGITAL POTENTIOMETER for the new choice. Descriptions of the available choices follow below.

An eight pressing returns the display to voltage or current readings as before the first LOCAL/FUNCTION pushbutton depression.

4.3.1 CHOICE OF OVERVOLTAGE TRIP RESPONSE ("OE")

When a unit detects that output voltage is above its programmed limit, it can respond by shutting itself off (tripping) the high voltage. The syntax is:

OE2 Establishes that the unit cannot be programmed to a voltage value above the voltage limit setting.

OE1 Enables the unit to shut down its output upon detection of an output voltage above the limit setting.

OE0 Establishes that the unit will not shut down its output in response to the detection of an output voltage above the voltage limit setting

4.3.2 CHOICE OF OVERCURRENT TRIP RESPONSE ("OC")

When a unit detects that output current is above its programmed limit, it can respond by shutting itself off (tripping) the high voltage. The syntax is:

OC1 Enables the unit to shut down its output upon detection of an output current above the limit setting

OC0 Establishes that the unit will not shut down its output in response to the detection of an output current above the voltage limit setting.

4.3.3 CHOICE OF OVERVOLTAGE SERVICE REQUEST RESPONSE ("SrE")

At the user's choice, the unit can be made to issue a service request to the GPIB controller in response to a voltage overload. The syntax is:

SrE1 Enables SRQ in response to an overvoltage detection.

SrE0 Disables SRQ in response to an overvoltage detection.

4.3.4 CHOICE OF OVERCURRENT SERVICE REQUEST RESPONSE ("SrC")

At the user's choice, the unit can be made to issue a service request to the GPIB controller in response to a current overload. The syntax is:

SrC1 Enables *SRQ* in response to an overcurrent detection.

SrC0 Disables *SRQ* in response to an overcurrent detection.

4.4 FRONT PANEL MESSAGES

DISPLAY MEANING

E r r	An erroneous command sequence has just been rejected
S E	The SET pushbutton has just been depressed.
A d	The ADJUST pushbutton has just been depressed.
L i	The LIMIT pushbutton has just been depressed.
A d r n n	The IEEE-488 GPIB address is the number "n n"
L L O	Local lockout is on.

4.5 OPERATION EXAMPLES

The following section describes sequences of local control command entry by way of examples. NOTE: Errors made during sequence entry will result in the error message ("E r r") being displayed on the front panel, but such errors will be rejected and not affect any previous programming.

The following are some common examples of NON-VALID sequences resulting in an "E r r" message display:

<u>COMMAND ENTRY</u>	<u>REASON FOR ERROR MESSAGE</u>
"ADJUST" "mA"	Cannot adjust power supply output current.
"SET" "mA"	Cannot set power supply output current.
"SET" "ENTER"	No controlled parameter, kV or mA, was selected.
"LIMIT" "ENTER"	No controlled parameter was selected.
"ADJUST" "ENTER"	No controlled parameter was selected.
"ENTER"	No controlled parameter or select function was selected.

4.5.1 OUTPUT VOLTAGE SETTING

Push "SET" button. "SET" LED lights and "SE" message is displayed.

Push "VOLTS" button: "VOLTS" LED lights and the last entered voltage setting value is displayed.

Turn the digital potentiometer knob for the desired output voltage. (The actual high voltage output will NOT change until the following step).

Push "ENTER" to finish the sequence. The "SET" and "VOLTS" LEDs will go off. If the High Voltage switch is on, the entered voltage value will be outputted and voltage measurements will be displayed.

4.5.2 OUTPUT VOLTAGE ADJUSTMENT

Push "ADJUST" button: The "ADJUST" LED lights and the "A d" message is displayed.

Push "VOLTS" button: The "VOLTS" LED lights and the output voltage is displayed.

Turn the digital potentiometer knob for the desired output voltage. **CAUTION: The ACTUAL high voltage output will start changing immediately in response to this step.**

Push "ENTER" to finalize the adjustment and to exit the adjustment.

4.5.3 SETTING THE OUTPUT VOLTAGE LIMIT

Push "LIMIT" button: The "LIMIT" LED lights and the "L i" message is displayed.

Push "VOLTS" button: The "VOLTS" LED lights and the preset limit voltage is displayed.

Turn the digital potentiometer knob to set the new desired limit.

Push the "ENTER" button to save the displayed entry as the new voltage limit value. The display then returns to presenting the previously measured parameter and the "LIMIT" and "VOLTS" LEDs go out.

4.5.4 SETTING THE OUTPUT CURRENT LIMIT

Push "LIMIT" button: The "LIMIT" LED lights and the "L i" message is displayed.

Push "mA" button: The "mA" LED lights and the preset limit current is displayed.

Turn the digital potentiometer knob to set a new desired limit. Push the "ENTER" button to save the displayed entry as the new current limit value. The display then returns to presenting the previously measured parameter and the "LIMIT" and "mA" LEDs go out.

SECTION V: REMOTE ANALOG OPERATION

CAUTION! THIS UNIT CAN STORE HAZARDOUS VOLTAGE. COMPLETELY DISCHARGE HIGH VOLTAGE AT REAR PANEL GROUND TERMINAL BEFORE ATTEMPTING REMOVAL OF THE HIGH VOLTAGE CABLE

5.1 PROGRAM CONTROL SWITCH

Before a unit can be programmed with a remote analog (0 to +5VDC) signal, it must be configured by setting its rear panel PROGRAM CONTROL switch (S101) in the REMOTE ANALOG. Note: All other monitoring and non-programming functions remain active, regardless of the S102 position.

5.2 REMOTE CONTROL

The high voltage output can be remotely programmed from an external voltage source. A 0 to +5VDC programming voltage applied to Pin 6 of the J107 (PROGRAMMING/MONITOR) connector jack on the rear panel will remotely program the high voltage output from zero to maximum voltage.

Programming can also be accomplished using a potentiometer connected between Pin 4 (+5VDC), Pin 7 (GND) with the wiper connected to Pin 6. The potentiometer should be a low temperature coefficient wirewound or cermet type of 5k Ω to 20k Ω resistance value. The output will then be in proportion to the wiper position.

5.3 ANALOG MONITORING SIGNALS

Analog monitoring signals of 0 to +5VDC via 10k Ω are provided, which are linearly proportional to the unit's output voltage and current. A TTL-compatible logic TRIP input, a +5VDC reference voltage output and an NPN open collector polarity indicator are all available at J107.

Figure 5.1 on the next page defines the pin locations and functions of the rear panel analog monitor and remote analog programming connector.

Figure 5.1

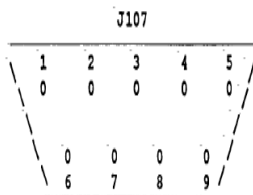

<u>PIN</u>	<u>FUNCTION</u>
1	Buffered output voltage monitor, 0 to +5VDC via 10k Ω
2	No connection
3	TTL level compatible logic input. Input logic zero disables high voltage generation. Open

- | | |
|---|---|
| 4 | Precision +5VDC reference output, referenced to analog ground. |
| 5 | Buffered output current monitor, 0 to +5VDC via 0k Ω |
| 6 | Remote analog programming input, 0 to +5VDC |
| 7 | Analog ground |
| 8 | Digital ground |
| 9 | NPN open collector with respect to digital ground, indicating output high voltage polarity. NPN saturation denotes positive polarity (logic 0), NPN cut-off denotes negative polarity (logic 1) |

SECTION VI: MAINTENANCE

6.1 GENERAL

Your 225 Series high voltage power supply is designed for reliable, trouble-free operation. If any questions should arise, contact Spellman's Customer Service Department for assistance or return authorization.

The power supply can be returned to the factory for annual calibration and certification to its original specifications. For traceability, a certificate will be issued, identifying the serial number of the unit calibrated and all test equipment used to perform the calibration. All measurements are traceable to the National Institute of Standards and Technology (NIST). Contact factory for additional details.

SECTION VII: APPENDIX

7.1 IBM PC/XT/AT (DOS 3.1 OR HIGHER REQUIRED)

- Equip the computer with the IO Tech Personal 488A Interface.
- Install software driver per the Personal 488A instructions.
- Set the address switches on the 225 Series to 7.
- Run the Basic interpreter with comes with the computer.
- Enter the lines of the program below using the return key after each line.
- Press RUN (F2) after the total program has been executed. Enter a command when prompted. For example, if you enter "P0.1000KG", wait approximately two seconds, and then enter "T1", the resulting display is nominally "N V0.1000K"

PROG. REMARKS

```
10 OPEN "\DEV\IEEEOUT" FOR OUTPUT
AS #1 Set up output file
20 IOCTL#1, "BREAK" Clear buffers in Basic
30 PRINT#1, "RESET" Init. the bus with IFC
40 OPEN "\DEV\IEEEIN" FOR INPUT AS#2
Set up input file to Basic
50 PRINT#1, "REMOTE 07" Place the 225 in
remote
60 INPUT "COMMAND"; A$
70 PRINT#1, "OUTPUT 07;" A$
Address 225 to listen and send the string
80 INPUT "COMMAND", A$
90 PRINT#1, "OUTPUT 07;" A$
100 PRINT#1, "ENTER 07" Address 225 to talk
110 LINE INPUT#2, A$ Input the bytes
120 PRINT A$ Display the reading
130 END
```

7.2 IBM PS/2 USING IO TECH INTERFACE (DOS 3.1 OR HIGHER REQUIRED)

1. Equip the computer with the IO Tech PS/2 488A Interface.
2. Install software driver per the PS/2 488A manual instructions.
3. Set the address switches on the 225 Series to 7.
4. Run the Basic interpreter with comes with the computer.
5. Enter the lines of the program below using the return key after each line.
6. Press RUN (F2) after the total program has been executed. Enter a command when prompted. For example, if you enter "P0.1000KG", wait approximately two seconds, and then enter "T1", the resulting display is nominally "N V0.1000K"

PROG. REMARKS

```
10 OPEN "\DEV\IEEEOUT" FOR OUTPUT AS
#1 Set up output file
20 IOCTL#1, "BREAK"
Clear buffers in Basic
30 PRINT#1, "RESET"
Init. the bus with IFC
40 OPEN "\DEV\IEEEIN" FOR INPUT AS#2
Set up input file to Basic
50 PRINT#1, "REMOTE 07"
Place the 225 in remote
60 INPUT "COMMAND"; A$
70 PRINT#1, "OUTPUT 07;" A$
Address 225 to listen and send the string
80 PRINT#1, "ENTER 07"
Address the 225 to talk
90 INPUT "COMMAND"; A$
100 PRINT#1, "OUTPUT 07;" A$
110 LINE INPUT#2, A$
Input the bytes
120 PRINT A$
Display the reading
130 END
```

7.3 HP 85/86/87

1. Equip the computer with an HP 82937 GPIB interface and an I/O ROM.
2. Set the address switches on the 225 Series to 7.
3. Enter the lines in the program below. Use the END LINE key after each line.
4. Press the RUN key when the total program is entered. Enter a command when prompted to do so. For example, if you enter "P0.1000KG", wait approximately two seconds, and then enter "T1", the resulting display will nominally show the string "N V0.1000K"

PROG. REMARKS

```
10 REMOTE 707
Place 225 in remote
20 DISP "Command"
Prompt for command
30 INPUT A$
40 OUTPUT 707A$
Address 225 to listen, send string
50 DISP "Command"
60 INPUT A$
70 OUTPUT 707;A$
80 ENTER 707;A$
Address 225 to talk, return reading
90 DISP A$
Display ready on CRT
100 END
```

7.4 HP9825A

1. Equip the computer with the HP98034A GPIB interface and the extended I/O ROM.
2. Set the address switches on the 225 Series to 7.
3. Enter the lines in the program below using the "STORE" key after each line.
4. Press the RUN key when the total program is entered. Enter a command when prompted to do so. For example, if you enter "P0.1000KG", wait approximately two seconds, and then enter "T1", the resulting display is nominally "N V0.1000K"

PROG. REMARKS

```
10 Rem 707
Place 225 in remote
20 Ent "COMMAND", A$
Prompt for command
30 Wrt 707, A$
Address 225 to listen, send command
40 Ent "COMMAND", A$
50 Ert "COMMAND", A$
60 Red 707, A$
Address 225 to talk, input reading
70 Prt A$
Print reading
```

7.5 FLOATING OPTION (“RF”):

The 225 Series can be purchased with a special option which allows the user to float the output above or below true earth (i.e., chassis) ground potential by as much as 2000V. All controls, programming and monitoring functions work normally and remain “ground-based” so there are no hazards with taking these measurements. The high voltage output polarity, with respect to the floating output terminal, is still reversible as in the standard version of the 225 Series.

In supplies so equipped with the floating option, the high voltage output current is no longer returned to the chassis of the power supply via either the shield of the HV output coaxial cable or the ground stud on the back of the supply. Instead, the user would now connect the low end of the application to a factory-installed MHV connector (jack) which is located on the rear panel of the 225 series HVPS. The shell of this connector is connected to chassis ground (as the actual HV output connector’s shell is) but the center conductor is the HV return.

To disable this feature on RF-equipped power supplies the user must connect a “dead-end” MHV plug to the HV return jack. A “dead end” connector would be one in which the center conductor is hard-wired to the shell. This reverts the 225 Series back to conventional ground-based operation.

The floating option is useful in applications where the low end cannot be connected directly to earth ground, or for other reasons is not desirable to do so. A current meter can also be inserted within this return path (with appropriate protection across the meter) for the purpose of measuring HV output current. We highly recommend installing back-to-back diodes or a neon bulb across the meter in the event that the meter connection is inadvertently or accidentally opened during operation. This will prevent the development of high voltage across the meter leads.

*

To obtain information on Spellman's product warranty please visit our website at:

<http://www.spellmanhv.com/en/About/Warranty.aspx>

