



- **8 Voltage Ranges from 62.5V to 6kV, Fixed Negative or Positive Polarity**
- **Available Output Power Increments of 4, 20 and 30 Watts**
- **Voltage/Current Regulation with Automatic Crossover Control**
- **Voltage and Current Monitor Signals**
- **Fully Arc and Short Circuit Protected**
- **Precision +5V Reference Output**
- **Comprehensive Standard Interface**
- **CE Listed, UL Recognized and RoHS Compliant**

www.spellmanhv.com/manuals/UM

Form, Fit and Function Design:

Spellman's UM Series of printed circuit board mountable, high voltage modules offer a form, fit and function replacement for presently available commercially made units, while providing additional features and benefits at competitive pricing. Utilizing proprietary power conversion technology and Spellman's six decades of high voltage experience, these SMT based high voltage modules provide improved performance/reliability and easier system integration at a lower cost when compared to the competition.

Advanced Power Conversion Topology:

UM converters use a proprietary zero voltage switching power conversion topology providing exceptional efficiency and inherent low noise and ripple. Radiated emissions are reduced compared to conventional switching topologies, minimizing or even eliminating the need to shield the unit from adjacent circuitry.

The high voltage output is generated using a ferrite core high voltage step up transformer which feeds the output circuitry. Units at 1kV or higher utilize an arrangement of half wave Cockcroft-Walton voltage multiplier stages to obtain the specified high voltage output, while lower voltage units use a robust rectification and filter circuit.

Due to the fixed, high frequency conversion rate the output capacitance is small resulting in minimal stored energy. Through the use of generously rated surge limiting resistors and a fast acting current loop, all units are fully arc and short circuit protected.

Control and Regulation:

The actual output voltage generated is sampled via a high impedance divider to create a voltage feedback signal. A current feedback signal is created via a current sense resistor in the low end return of the high voltage output circuitry. These two accurate ground referenced feedback signals are used to precisely regulate and control the units in addition to external monitoring purposes.

Due to the UM's unique converter topology it can provide full current into low impedance loads or even a short circuit. Standard units limit at 103% of maximum rated output current.

Standard Interface:

The Spellman UM Series interface provides current programming capability and positive polarity, buffered, low output impedance voltage and current monitor signals (zero to +4.64Vdc equals zero to full scale rated). A voltage programming input is provided where 0 to +4.64Vdc equals 0 to 100% of rated voltage.

Current programmability allows the user to set where the unit will current limit, anywhere from 0 to 100% of maximum rated current. This feature is beneficial where less than full output current is desired, like in the case of protecting a sensitive load.

The buffered low impedance voltage and current monitor signals can drive external circuitry directly, while minimizing loading and pickup effects. These features save the user the expense and implementation of external interface buffering circuitry while improving overall signal integrity.

This standard interface is made available via a row of 13 pins with 0.1" pin spacing. A legacy interface (7 pins on a 0.2" spacing) that is compatible with presently available commercially made units can be provided by ordering the "L" option.

Mechanical and Environmental Considerations:

The UM Series are solid encapsulated, printed circuit board mountable, plastic cased converters measuring only 2.97" X 1.5" X 0.83" (75.4mm X 38.1mm X 21.1mm). All units are encapsulated using a silicon based potting material which is considerably lighter in weight than epoxy. Two isolated, non grounded 2-56 machine screws thread into the module to securely mount it to the printed circuit board, relieving any stress on the interface pins. Mounting plates, brackets and flanged mounting options are also available

Regulatory Approvals:

Compliant to EEC EMC Directive. Compliant to EEC Low Voltage Directive. UL/CUL recognized, File E227588. RoHS Compliant.

SPECIFICATIONS

Input Voltage:

12Vdc for 4W, 24Vdc for 20W and 30W

Nominal Voltage Range:

11Vdc to 30Vdc for 4W, 23Vdc to 30Vdc for 20W and 30W

Input Current: (typical)

Disabled: 30mA
 No load: 90mA
 Full load:
 4 watt units: 0.5A
 20 watt units: 1.0A
 30 watt units: 1.5A

Efficiency:

80-85%, typical

Voltage Regulation:

Line: <0.01%
 Load: <0.01%

Current Regulation:

Line: <0.01%
 Load: <0.01%

Stability:

0.01% per 8 hours, 0.02% per day after 30 min. warmup

Accuracy:

2% on all programming and monitoring, except I Sense 10%

Temperature Coefficient: (typical)

Standard: 100ppm/°C
 Optional: 25ppm/°C (T Option)

Environmental:

Temperature Range:
 Operating: 0°C to 65°C case temperature
 Storage: -55°C to 85°C, non operational
 Humidity:
 10% to 90%, non-condensing.

Cooling:

Convection cooled, typical. 30 watt units operating at full power might require additional cooling to maintain case temperature below 65°C. Methods may include: forced air cooling, use of heat sink or metal case, etc. It is the user's responsibility to maintain the case temperature below 65°C. Damage to the power supply due to inadequate cooling is considered misuse and repairs will not be covered under warranty.

Dimensions:

2.96" L X 1.49" W X 0.81" H
 (75.2mm X 37.9mm X 20.6mm)

Weight:

4 oz. (113g), typical

UM 4W SELECTION TABLE

Model Number	Output V	Output Current	Low Freq. Ripple %Vp-p @ 1Hz-1kHz	High Freq. Ripple %Vp-p @ 1kHz-1MHz	Output Capacitance	Arc Limiting Resistance	I Sense Scaling Full Scale Signal	High Voltage Divider Resistance
UM0.062*4	0 to 62.5V	64mA	0.030	0.028	8.8µF	1Ω	1.5V	0.5MΩ
UM0.125*4	0 to 125V	32mA	0.045	0.014	8.8µF	4.4Ω	2.75V	0.88MΩ
UM0.25*4	0 to 250V	16mA	0.034	0.017	2.2µF	20Ω	4.9V	1.50MΩ
UM0.5*4	0 to 500V	8mA	0.036	0.040	0.8µF	94Ω	10.1V	2.65MΩ
UM1*4	0 to 1KV	4mA	0.025	0.015	0.2µF	470Ω	10.75V	20MΩ
UM2*4	0 to 2kV	2mA	0.022	0.015	0.097µF	1.0KΩ	10.4V	30MΩ
UM4*4	0 to 4kV	1mA	0.019	0.017	0.012µF	9.4KΩ	11.1V	100MΩ
UM6*4	0 to 6kV	0.67mA	0.016	0.015	0.007µF	20KΩ	9.9V	150MΩ

UM 20W SELECTION TABLE

Model Number	Output V	Output Current	Low Freq. Ripple %Vp-p @ 1Hz-1kHz	High Freq. Ripple %Vp-p @ 1kHz-1MHz	Output Capacitance	Arc Limiting Resistance	I Sense Scaling Full Scale Signal	High Voltage Divider Resistance
UM0.062*20	0 to 62.5V	320mA	0.060	0.088	8.8µF	1Ω	330mV	0.5MΩ
UM0.125*20	0 to 125V	160mA	0.067	0.044	8.8µF	4.4Ω	675mV	0.88MΩ
UM0.25*20	0 to 250V	80mA	0.035	0.019	2.2µF	20Ω	1.135V	1.50MΩ
UM0.5*20	0 to 500V	40mA	0.041	0.040	0.8µF	94Ω	2.25V	2.65MΩ
UM1*20	0 to 1KV	20mA	0.039	0.095	0.2µF	470Ω	4.35V	20MΩ
UM2*20	0 to 2kV	10mA	0.026	0.016	0.097µF	1.0KΩ	6.6V	30MΩ
UM4*20	0 to 4kV	5mA	0.023	0.028	0.012µF	9.4KΩ	6.65V	100MΩ
UM6*20	0 to 6kV	3.3mA	0.017	0.018	0.007µF	20KΩ	6.74V	150MΩ

UM 30W SELECTION TABLE

Model Number	Output V	Output Current	Low Freq. Ripple %Vp-p @ 1Hz-1kHz	High Freq. Ripple %Vp-p @ 1kHz-1MHz	Output Capacitance	Arc Limiting Resistance	I Sense Scaling Full Scale Signal	High Voltage Divider Resistance
UM0.062*30	0 to 62.5V	480mA	0.075	0.112	8.8µF	1Ω	500mV	0.5MΩ
UM0.125*30	0 to 125V	240mA	0.075	0.056	8.8µF	4.4Ω	930mV	0.88MΩ
UM0.25*30	0 to 250V	120mA	0.055	0.031	2.2µF	20Ω	1.65V	1.50MΩ
UM0.5*30	0 to 500V	60mA	0.085	0.041	0.8µF	94Ω	3.4V	2.65MΩ
UM1*30	0 to 1KV	30mA	0.032	0.171	0.2µF	220Ω	6.5V	20MΩ
UM2*30	0 to 2kV	15mA	0.031	0.112	0.097µF	470Ω	9.85V	30MΩ
UM4*30	0 to 4kV	7.5mA	0.028	0.071	0.012µF	4.4KΩ	9.85V	100MΩ
UM6*30	0 to 6kV	5mA	0.020	0.051	0.007µF	9.4KΩ	10.0V	150MΩ

Note: Total ripple is the sum of the low frequency and high frequency ripple. Grayed text indicates Legacy interface signals.



STANDARD INTERFACE

PIN	SIGNAL	PARAMETERS
1	Power Ground Return	+12Vdc or +24Vdc power return/HV return
1A	Signature Resistor	Unique Identifying resistor connected to ground
2	+ Power Input	+12Vdc or +24Vdc power input
2A	N/C	
3	I Sense	See I Sense text and tables
3A	I Mon	0 to 4.64Vdc = 0 to 100% rated output. Zout < 10kΩ
4	Enable Input	Low (<0.7V, Isink@1mA)=HV OFF, High (open or >2V)=HV ON
4A	V Mon	0 to 4.64Vdc = 0 to 100% rated output. Zout < 10kΩ
5	Signal Ground	Signal Ground
5A	I Pgm	0 to 4.64Vdc = 0 to 100% rated output. Zin > 47kΩ Leave open for preset current limit @103% of rated output current
6	Remote Adjust	Positive Polarity Unit: 0 to +4.64VDC = 0 to 100% rated voltage, Zin > 1MΩ Negative Polarity Unit: +5VDC to 0.36V = 0 to 100% rated voltage, Zin > 100kΩ Leave open if pin 6A (VPgm) is used for programming
6A	V Pgm	0 to 4.64Vdc = 0 to 100% rated voltage. Zin > 100kΩ Leave open if pin 6 (remote adjust) is used for programming
7	+5V Reference Output	+5Vdc ±0.5%, 50ppm/°C. Zout =475Ω
8	HV Ground Return	HV Ground Return
9	E Out Monitor	10:1 ratio for models below 1kV, 100:1 ratio for models 1kV and above. Polarity of Voltage Monitor signal equals polarity of unit. Accuracy is ±2%, 100ppm/°C. Calibrated with DVM with 10MΩ input impedance
10	HV Output	HV Output
11	HV Output	HV Output

Grayed out signals are provided for backward legacy compatibility and their use is not required

Power Ground Return, Signal Ground and HV Ground Return are connected internally. For best performance they should not be connected externally.

Standard Interface Connections

Seventeen (17) gold plated 0.025" (0.64mm) square pins suitable for direct PCB mounting. See mechanical drawing for location and spacing details.

Programming and Monitor Signals

Voltage and current programming is done via positive polarity, high input impedance, 0 to 4.64Vdc signals.

Voltage and current monitors are positive polarity, buffered low output impedance 0 to 4.64Vdc signals.

I Mon

The I Mon signal is a true output current monitoring signal. All internal offsets due to feedback divider currents have been compensated for.

Signature Resistor

A unique identifying signature resistor for each type of unit is connected from Pin 1A to ground. Details if desired are available upon request.

Legacy Interface Connections

Eleven (11) gold plated 0.025" (0.64mm) square pins suitable for direct PCB mounting. See mechanical drawing for location and spacing details.

I Sense Signal

The I Sense signal polarity is opposite of the output polarity of the module. This signal is protected via a transistor and provided via a series connected 47k isolation resistor. Internal HV dividers create a small, linear offset voltage on the I sense signal that can be compensated for.

Adhesive Backed Heat Sink

UM modules are provided with an uninstalled top mounted adhesive backed heat sink. Label removal is not required if the customer elects to install and use the provided heat sink.

The UM's internal power dissipation causes a case temperature rise. If the case exceeds 65°C, the unit needs external cooling (fan or heat sink). Even if the case is below 65°C, it is prudent to keep it much lower. Like a semiconductor device; the hotter it is, the shorter the life. For every 10°C reduction of temperature the lifetime will be increased by a factor of ≈2.35. The thermal resistance from internal circuitry to ambient is 8°C/watt without a heat sink (still air). This reduces to 6°C/watt with the heat sink.

Example:

Assuming ≈80% efficiency for a 20 watt UM module, the 5 watts of internal power dissipation would create a 40°C rise. Using the heat sink there would be only a 30°C rise. Ultimately it is up to the user to determine what cooling method is applicable for their application, but the general recommendation is to keep the module as cool as possible.

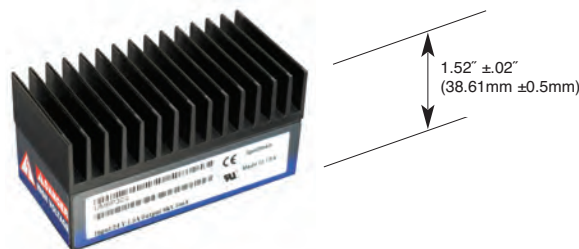

LEGACY INTERFACE (L OPTION)

PIN	SIGNAL	PARAMETERS
1	Power Ground Return	+12Vdc or +24Vdc power return/HV return
2	+ Power Input	+12Vdc or +24Vdc power input
3	I Sense	See I Sense text and tables for details
4	Enable Input	Low (<0.7V, Isink@1mA)=HV OFF, High (open or >2V)=HV ON
5	Signal Ground	Signal Ground
6	Remote Adjust	Positive Polarity Unit: 0 to +4.64VDC = 0 to 100% rated voltage, Zin > 1MΩ Negative Polarity Unit: +5VDC to 0.36V = 0 to 100% rated voltage, Zin > 100kΩ
7	+5V Reference Output	+5Vdc ±0.5%, 50ppm/°C. Zout =475Ω
8	HV Ground Return	HV Ground Return
9	E Out Monitor	10:1 ratio for models below 1kV, 100:1 ratio for models 1kV and above. Polarity of Voltage Monitor signal equals polarity of unit. Accuracy is ±2%, 100ppm/°C. Calibrated with DVM with 10MΩ input impedance
10	HV Output	HV Output
11	HV Output	HV Output

Power Ground Return, Signal Ground and HV Ground Return are connected internally. For best performance they should not be connected externally.

UM OPTIONS

C Option

Fast Rise Time Applications-

If applications demand a power supply that is optimized for fast rise time/low overshoot requirements, then the C Option should be considered. A Hysteretic control circuit is employed providing improved performance in these unique applications with higher ripple observed (1% Vpp typical). If used for capacitor charging, a Spellman Capacitor Charging Questionnaire should be filled out to assure all aspects of the intended usage is understood assuring the appropriate unit is provided. Speak to a Spellman sales person for more details.

Maximum short circuit discharge rate:

$$\frac{CV^2}{2} (f) < 1 \text{ watt}$$

C = Output capacitance of unit
 C ext = External capacitance
 V = Maximum rated voltage
 f = Frequency of discharge
 I = Nominal output current
 t_R = Rise time

T Option

Low Temperature Coefficient-

The T Option offers the UM with an improved temperature coefficient. The standard voltage feedback divider is replaced with one having a superior temperature coefficient, resulting in a unit with 25ppm/C° (typical) temperature coefficient.

Typical Rise Time:

$$t_R = \frac{C + C_{ext}}{I} (V)$$

Minimum rise time is 3mS

PHYSICAL INTERFACING

A Option

Adapter Board-

Spellman's UM module can be fitted with an adapter board that will allow a drop in replacement for other commercially available modules of a physically larger size, while providing identical functionality with superior performance.

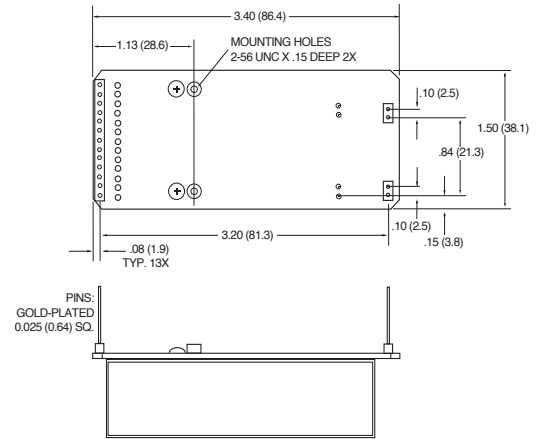
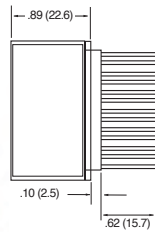

B Option

Terminal Block-

The B Option provides terminal block connections for both the customer interface and high voltage output/return. This feature can be helpful in situations where frequent wiring changes are anticipated, as in a testing or prototype environment.

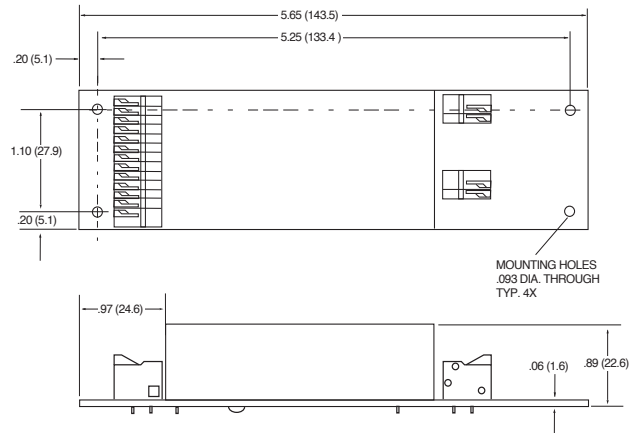
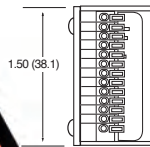

SHIELDING

M Option

Mu Metal Shield-

UM modules can be fitted with an adhesive backed Mu Metal foil shield to help protect sensitive adjacent circuitry.



Same as standard unit.
 See page 6 of 6 for dimensional drawings

SHIELDING continued

S Option

RF Tight Shielded Can-

The S Option mounts the UM module inside of a flanged RF tight aluminum can.

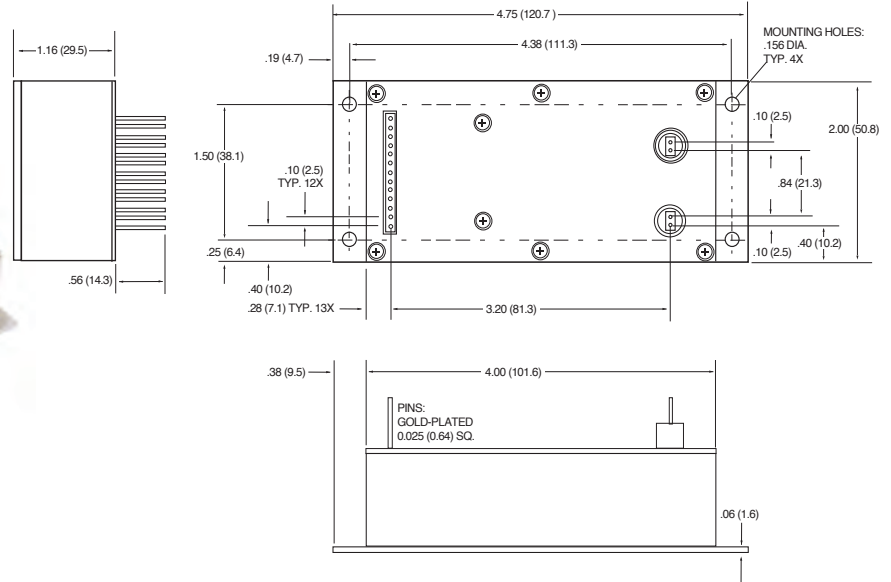

CHASSIS MOUNTING

E Option

Eared Mounting Plate-

An eared mounting plate is affixed to the top surface of the UM module allowing simple chassis mounting of unit.

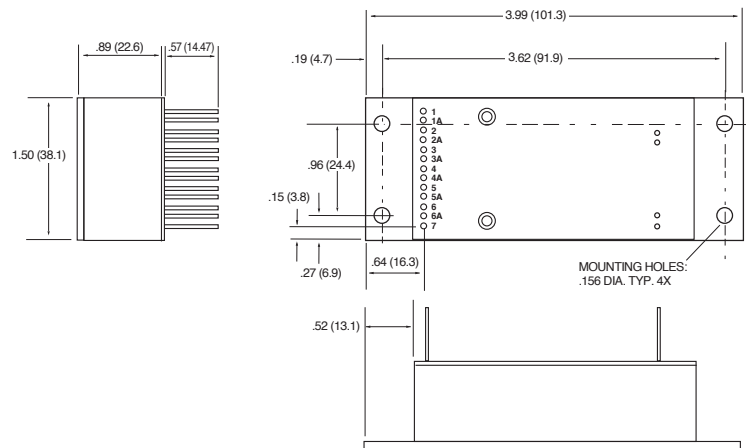
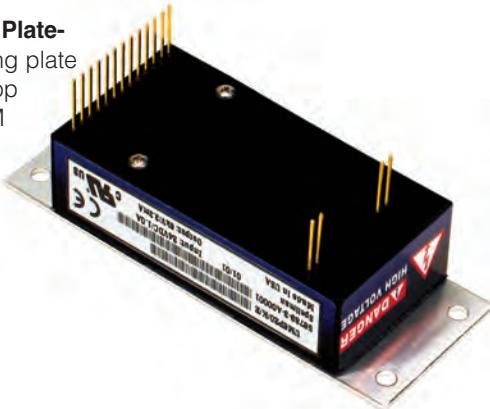

E2 Option

Eared Mounting Plate-

An eared mounting plate is affixed to the top surface of the UM module allowing simple chassis mounting of units ordered with the Adapter Board (A Option).

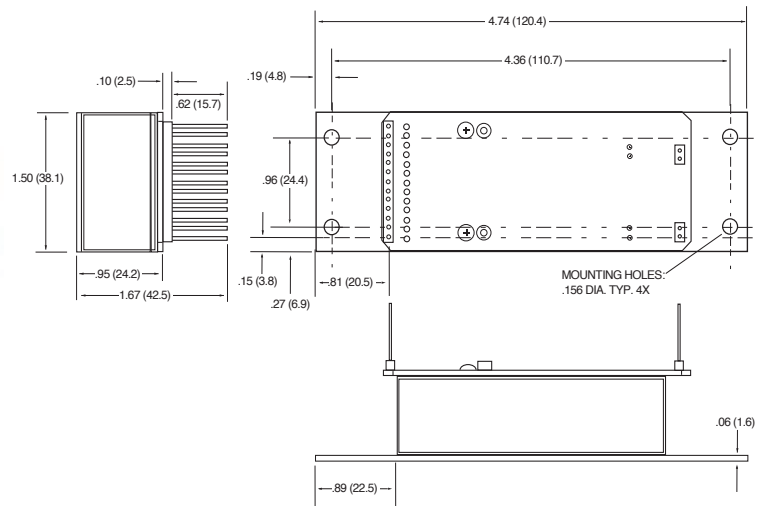
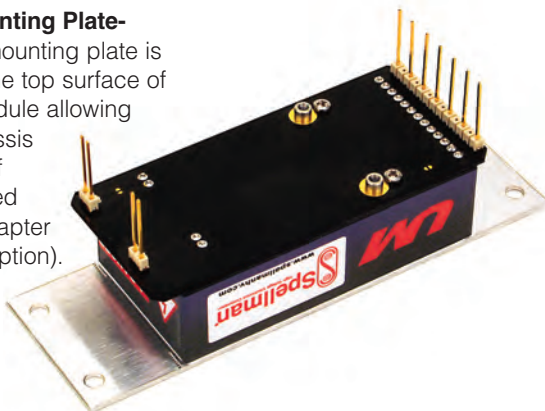

DIMENSIONS: in.[mm]

17 PIN - Standard Interface

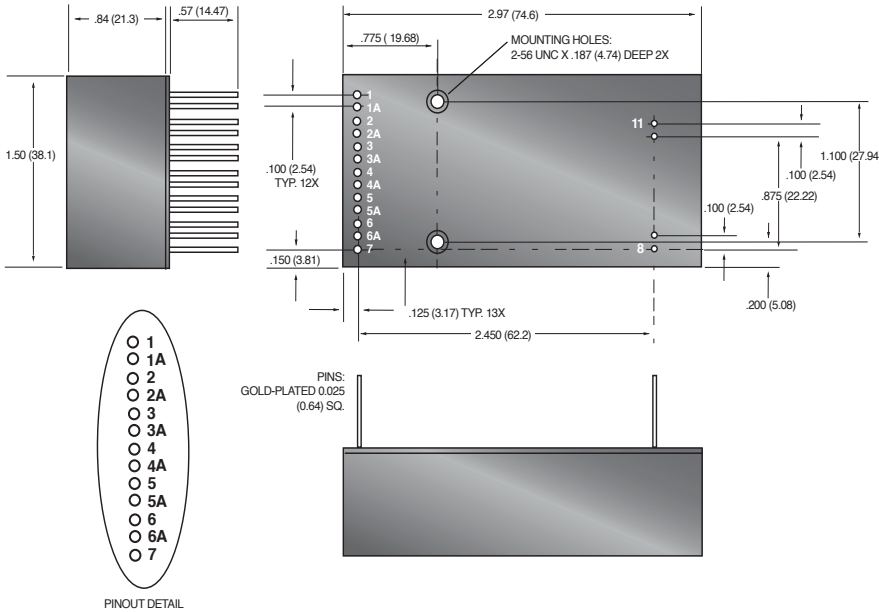

11 PIN - Legacy Interface

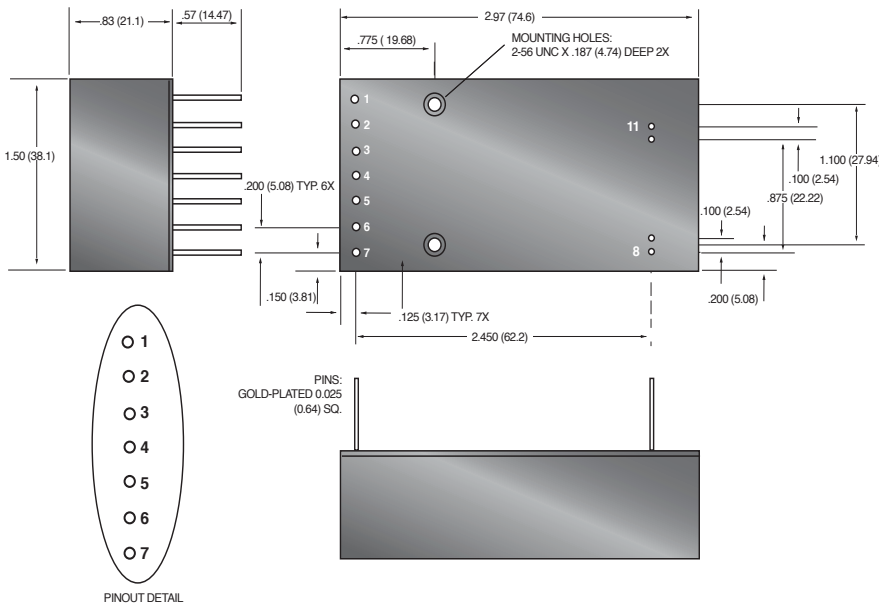

Note: There may be some restrictions on multiple option combinations. Please contact our sales department for more details.

ORDERING INFORMATION

Voltage	0 to 62.5Vdc	0.062
	0 to 125Vdc	0.125
	0 to 250Vdc	0.25
	0 to 500Vdc	0.5
	0 to 1000Vdc	1
	0 to 2000Vdc	2
	0 to 4000Vdc	4
Polarity	Positive	P
	Negative	N
Power	Watts Output	4
	Watts Output	20
	Watts Output	30

STANDARD UNIT ORDERING EXAMPLE

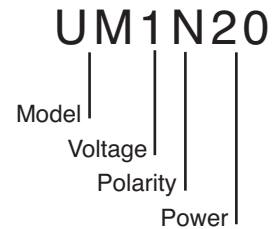

OPTION ORDERING INFORMATION

OPTION	OPTION CODE
Legacy Interface	L
Fast Rise Time	C
Low Temperature Coefficient	T
Adapter Board	A
Terminal Block	B
Mu Metal Shield	M
RF Tight Shielded Can	S
Eared Mounting Plate	E
Eared Mounting Plate/Adapter Board	E2

OPTION ORDERING EXAMPLE

